

Job Customer:

Title:

Ref:

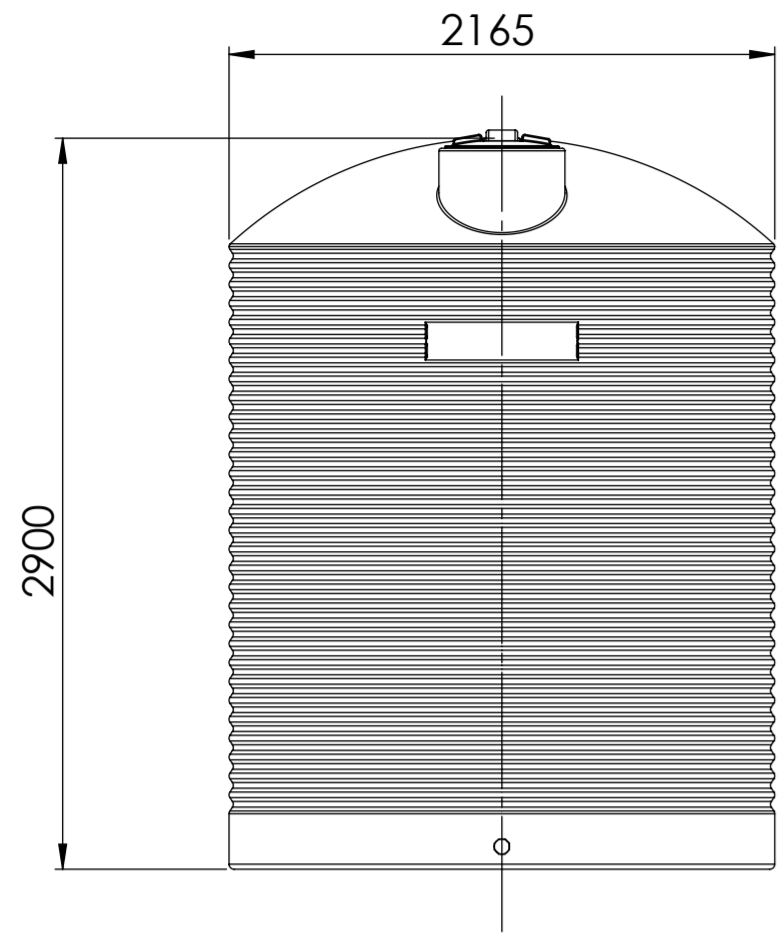

0°

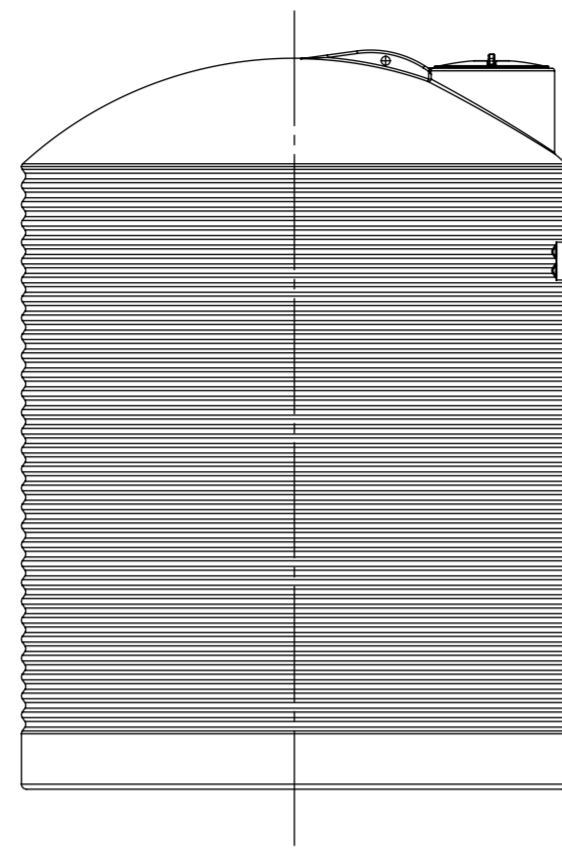

90°

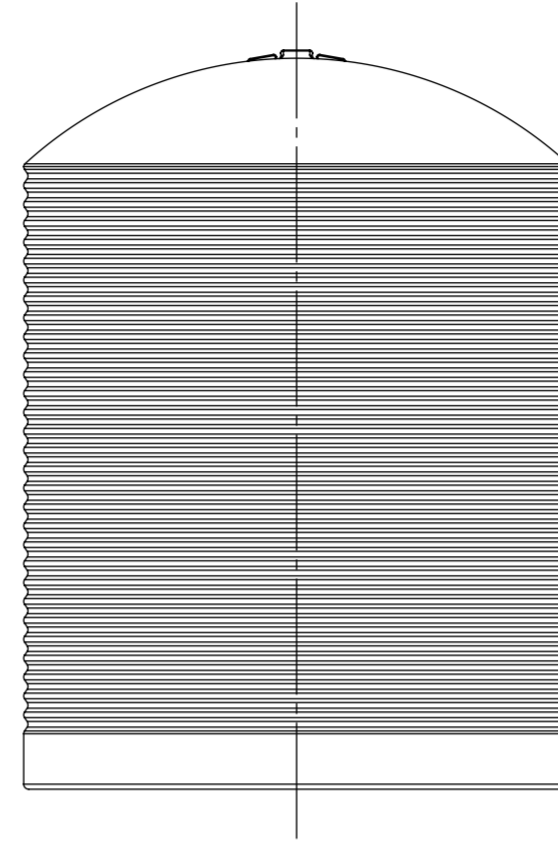

180°

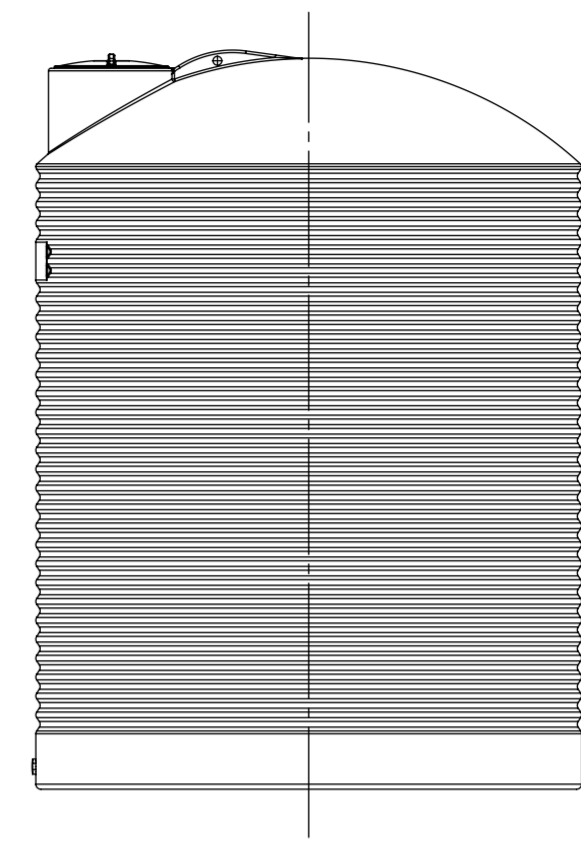

270°

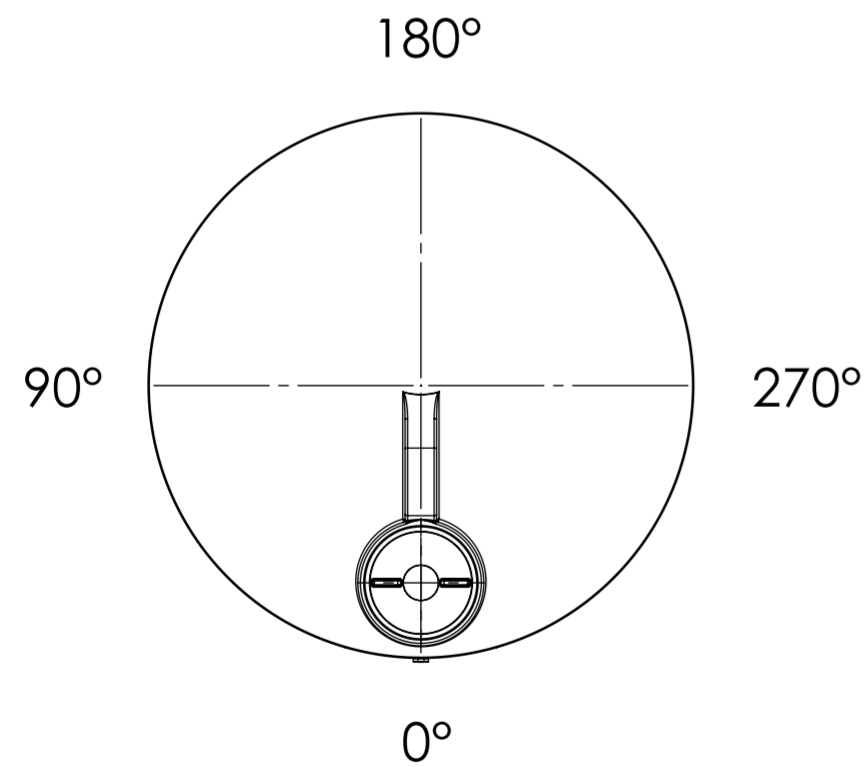

180°

90°

270°

0°

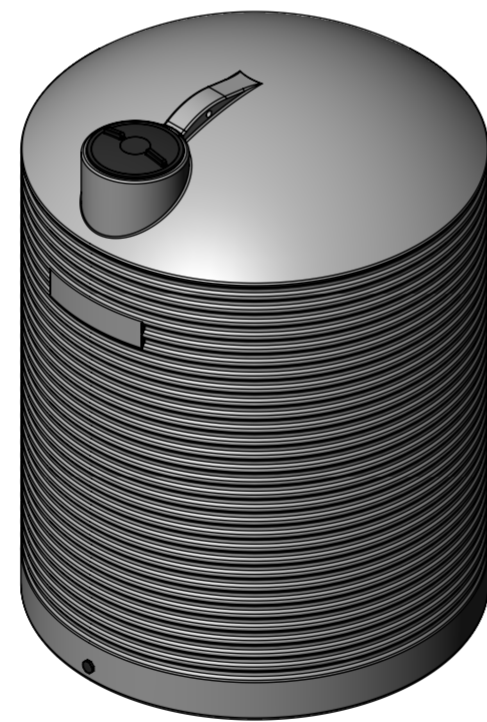

FITTING LAYOUT TABLE				PART LIST	
NOZZLE No.	DN/PE SIZE	ANGLE	DESCRIPTION	PART No.	NAME
N1	50/-	0°			(Mould in, 50mm Female)
N2	50/-	90°			(Mould in, 50mm Female)

NOTE:
 1. ALL DIMENSIONS ARE IN mm
 2. TOLERANCE: 3%
 3. ANY CHANGES MARK UP IN RED

CLIENT APPROVAL
<input type="checkbox"/> APPROVED <input type="checkbox"/> REVISE AND RESUBMIT <input type="checkbox"/> FOR INFORMATION ONLY
DATE:

SIGNATURE

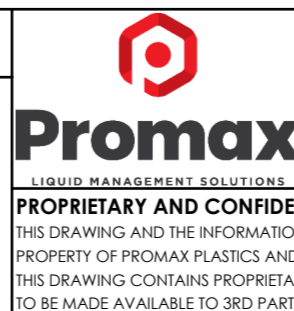

DO NOT SCALE DRAWING

ORIGINAL ISSUE: 12/10/2023

THIS DRAWING AND THE INFORMATION AND TECHNICAL DATA CONTAINED HEREIN ARE THE EXCLUSIVE PROPERTY OF PROMAX PLASTICS AND SHALL BE RETURNED TO THEM UPON REQUEST. THIS DRAWING CONTAINS PROPRIETARY AND CONFIDENTIAL INFORMATION FOR THIS PROJECT AND IS NOT TO BE MADE AVAILABLE TO 3RD PARTIES WITHOUT THE EXPRESS WRITTEN CONSENT OF PROMAX PLASTICS.

OPP:

AUTHOR: B.H.

MATERIAL: LLDPE

WEIGHT: 175

DISPLAY NAME/NUMBER:
 ENDURO Water Tank
 10,000 Ltr - North Island
 (EN1010000)

DWG NO.
 MODIFICATION PLAN

SCALE: 1:30

SHEET 1 OF 1

A2